

Dokumentation

Schnellentlüftungsventile ***- Typ SE ..., SV ..., SE ... ESG, SE ... K ES -***



1. Inhalt

1. Inhaltsverzeichnis	1
2. Schnellentlüftungsventile	1
2.1 Artikelnummern und technische Daten	1
2.2 Abmessungen Typ SE	2
2.3 Abmessungen Typ SV	2
3. Schnellentlüftungsventile aus Edelstahl	3
3.1 Artikelnummern und technische Daten	3
3.2 Abmessungen	3
4. Schnellentlüftungsventile aus Edelstahl, kompakt	3
4.2.1 Artikelnummern und technische Daten	3
4.2 Abmessungen	3

2. Schnellentlüftungsventile

2.1 Artikelnummern und technische Daten

Schnellentlüftungsventile

Präzisionsausführung:

Werkstoffe: Körper: Aluminium eloxiert, Dichtungen: NBR

Temperaturbereich: -10°C bis max. +70°C

Betriebsdruck: 0,5 bis 10 bar

Medien: geölte und ungeölte, gefilterte Druckluft

Standardausführung:

Werkstoffe: Körper: Messing vernickelt, Dichtungen: NBR/Polyurethan

Temperaturbereich: -20°C bis max. +70°C

Betriebsdruck: 1 bis 10 bar

Medien: geölte und ungeölte, gefilterte Druckluft

 **Optional:** FKM-Dichtung (-20°C bis max. +150°C) -V



Schalldämpfer
ab Seite 724

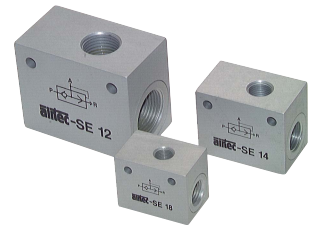

Präzisionsausführung

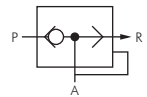

Funktion: Diese Ventile werden verwendet, um Zylinder sehr schnell zu entlüften und damit die Zylindergeschwindigkeit zu erhöhen. Sie werden dazu mit dem Anschluss A direkt an den Zylinder geschraubt.

Belüftung: Die von dem Steuerventil strömende Luft kann von Anschluss P ungehindert zu Anschluss A strömen.

Entlüftung: Wenn das Steuerventil auf Entlüftung schaltet, wird P drucklos. Das Ventil schaltet auf Durchfluss von A nach R und die Luft aus dem Zylinder kann ungehindert ins Freie entlüften.



Achtung! Nur bei Zylindern anwenden, bei denen für eine ausreichende Dämpfung in den Endlagen gesorgt ist (einstellbare Entlagendämpfung, Stoßdämpfer).

Bei Verwendung eines Schalldämpfers in Anschluss R muss dieser groß genug dimensioniert sein um Staudruck zu vermeiden. (Wir empfehlen unsere Schalldämpfer ab Seite 724.)

Typ	Gewinde A	Gewinde P	Gewinde R	Belüftung P → A	Entlüftung A → R	Ersatz- membrane 
Präzisionsausführung						
SE 18	G 1/8"	G 1/8"	G 1/4"	600 l/min.	1200 l/min.	---
SE 14	G 1/4"	G 1/4"	G 3/8"	1200 l/min.	2400 l/min.	---
SE 12	G 1/2"	G 1/2"	G 3/4"	2800 l/min.	5600 l/min.	---
Standardausführung						
SV 25	M5	M5	M5	220 l/min.	300 l/min.	SV 25 MEMBRANE
SV 18	G 1/8"	G 1/8"	G 1/8"	650 l/min.	1100 l/min.	SV 18 MEMBRANE
SV 14	G 1/4"	G 1/4"	G 1/4"	1200 l/min.	2250 l/min.	SV 1438 MEMBRANE
SV 38	G 3/8"	G 3/8"	G 3/8"	1200 l/min.	2250 l/min.	SV 1438 MEMBRANE
SV 12	G 1/2"	G 1/2"	G 1/2"	3200 l/min.	7400 l/min.	SV 12 MEMBRANE
SV 34	G 3/4"	G 3/4"	G 3/4"	3800 l/min.	14000 l/min.	SV 34 MEMBRANE
SV 10	G 1"	G 1"	G 1"	6280 l/min.	15900 l/min.	SV 10 MEMBRANE

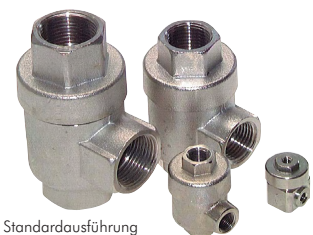

Standardausführung

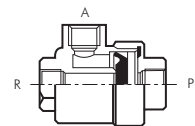

 **Bestellbeispiel:** SV 12 **



2.2 Abmessungen Typ SE ...

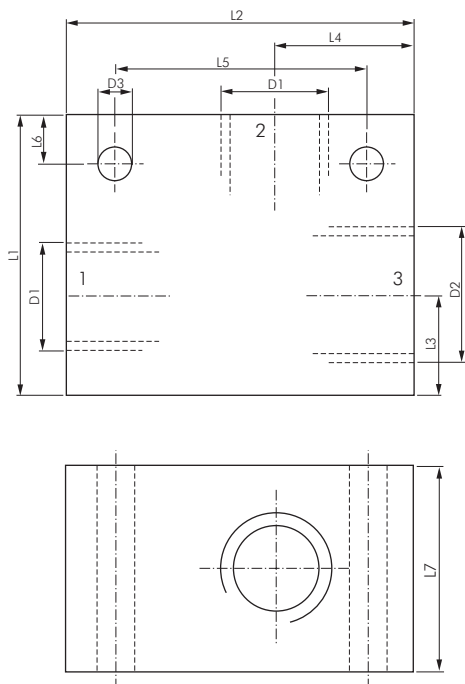

Typ	D1	D1	D3	L1	L2	L3	L4	L5	L6	L7
SE 18	G 1/8"	G 1/4"	4,5	32	40	12,5	18	24	6	25
SE 14	G 1/4"	G 3/8"	5,5	40	50	15,0	20	36	7	30
SE 12	G 1/2"	G 3/4"	6,6	56	70	20,0	28	50	10	40

2.3 Abmessungen Typ SV ...

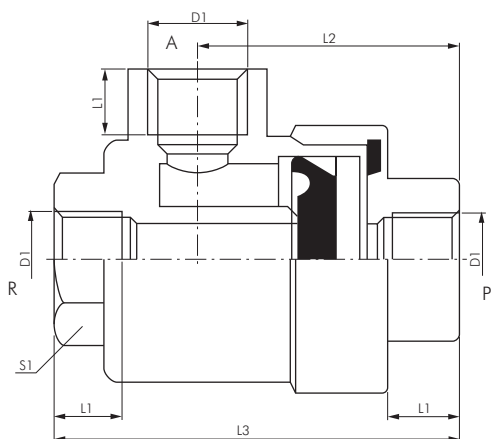

Typ	D1	L1	L2	L3	S1
SV 25	M5	5,0	17	25	10
SV 18	G 1/8"	6,5	27	42	15
SV 14	G 1/4"	9,5	35	53	19
SV 38	G 3/8"	11,0	35	54	19
SV 12	G 1/2"	13,0	43	72	26
SV 34	G 3/4"	16,3	53	87	32
SV 10	G 1"	18,0	70	108	46

3. Schnellentlüftungsventile aus Edelstahl

3.1 Artikelnummern und technische Daten

Schnellentlüftungsventile aus Edelstahl

Werkstoffe: Körper: 1.4404, Dichtungen: FKM (G 3/8"-G 1/2": PUR)
Temperaturbereich: -10°C bis max. +120°C (G 3/8"-G 1/2": max. +80°C)
Betriebsdruck: 2 - 10 bar
Medien: geölte und ungeölte Druckluft sowie ungiftige Gase (50 µm)

Typ	Gewinde	Durchfluss (Zylinder → Entlüftung)	Durchfluss (Eingang → Zylinder)
SE 14 ESG	G 1/4"	1900 l/min	1650 l/min
SE 38 ESG	G 3/8"	2880 l/min	2350 l/min
SE 12 ESG	G 1/2"	6400 l/min	4580 l/min

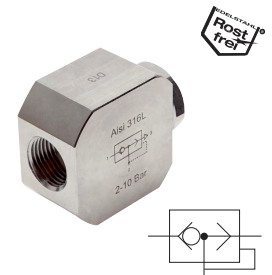

3.2 Abmessungen

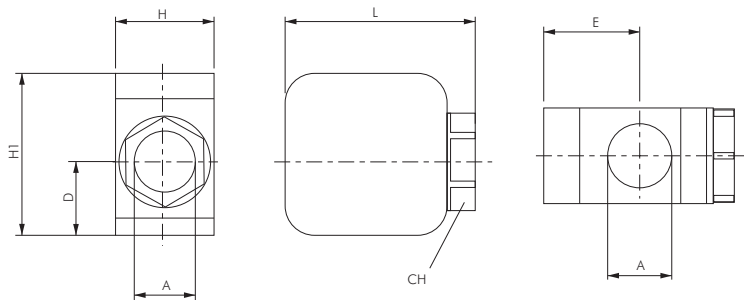

Typ	A	H	L	H1	E	D	CH
SE 14 ESG	G 1/4"	20	40,0	33	23,0	13,5	18
SE 38 ESG	G 3/8"	24	50,0	43	24,0	20,0	21
SE 12 ESG	G 3/2"	30	58,5	50	29,5	22,5	27

4. Schnellentlüftungsventile aus Edelstahl, kompakt

4.1 Artikelnummern und technische Daten

Schnellentlüftungsventile aus Edelstahl (inkl. Schalldämpfer)

Kompakt

Werkstoffe: Körper: 1.4404, Dichtungen: FKM, Dämpfermaterial: 1.4401
Temperaturbereich: -10°C bis max. +150°C
Betriebsdruck: 2 - 10 bar
Medien: gefilterte, geölte und ungeölte Druckluft

Typ	Gewinde	Durchfluss (Zylinder → Entlüftung)	Durchfluss (Eingang → Zylinder)
SE 14 K ES	G 1/4"	780 l/min	1080 l/min
SE 38 K ES	G 3/8"	1920 l/min	2170 l/min
SE 12 K ES	G 1/2"	2550 l/min	3250 l/min



4.2 Abmessungen

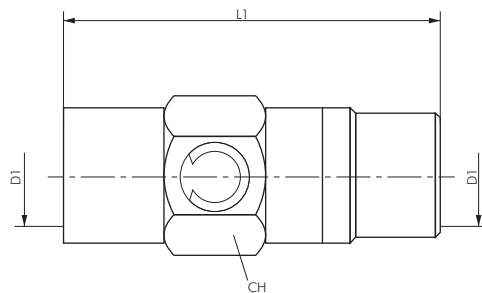

Typ	D1	L1	CH
SE 14 ESG	G 1/4"	50	18
SE 38 ESG	G 3/8"	61	27
SE 12 ESG	G 3/2"	69	35

Documentation

Quick exhaust valve

- Type SE ..., SV ..., SE ... ESG, SE ... K ES -



1. Content

1. Content	1
2. Quick exhaust valve	1
2.1 Articulenumbers and technical data	1
2.2 Dimensions Type SE	2
2.3 Dimensions Type SV	2
3. Quick exhaust valves made from stainless steel	3
3.1 Articulenumbers and technical data	3
3.2 Dimensions	3
4. Stainless steel clamp venting valve, compact	3
4.1 Articulenumbers and technical data	3
4.2 Dimensions	3

2. Quick exhaust valve

2.1 Articulenumbers and technical data

Quick exhaust valve

Precision version:

Materials: Body: anodized aluminium, seals: NBR

Temperature range: -10°C to max. +70°C

Operating pressure: 0,5 to 10 bar

Media: oiled and unoled filtered compressed air

Standard design:

Materials: Body: Nickel-plated brass, seals: NBR / Polyurethane

Temperature range: -20°C to max. +70°C

Operating pressure: 1 to 10 bar

Media: oiled and unoled filtered compressed air

 **Optional:** FKM seal (-20°C to max. +150°C) -V

Function: These valves are used to vent the cylinders quickly and enhance the cylinder speed. For this, they are screwed directly on the cylinder using the connection A. Breathing: The air flowing through the control valve can flow continuously from connection P to the connection A. Venting: When the control valve switches over to venting, P becomes depressurized. The valve switches to flow from A to R and the air from the cylinder can be freely vented into the open.



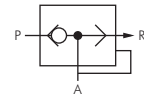

Precision version



Only for use in cylinders where there is sufficient end position damping (adjustable cushion, shock absorber).

When using a silencer in connection R, this must be large enough to avoid dynamic pressure.

Type	Connection			Breathing P → A	Venting A → R	Reparation- membrane 
	A	P	R			
Precision version						
SE 18	G 1/8"	G 1/8"	G 1/4"	600 l/min.	1200 l/min.	---
SE 14	G 1/4"	G 1/4"	G 3/8"	1200 l/min.	2400 l/min.	---
SE 12	G 1/2"	G 1/2"	G 3/4"	2800 l/min.	5600 l/min.	---
Standard design						
SV 25	M5	M5	M5	220 l/min.	300 l/min.	SV 25 MEMBRANE
SV 18	G 1/8"	G 1/8"	G 1/8"	650 l/min.	1100 l/min.	SV 18 MEMBRANE
SV 14	G 1/4"	G 1/4"	G 1/4"	1200 l/min.	2250 l/min.	SV 1438 MEMBRANE
SV 38	G 3/8"	G 3/8"	G 3/8"	1200 l/min.	2250 l/min.	SV 1438 MEMBRANE
SV 12	G 1/2"	G 1/2"	G 1/2"	3200 l/min.	7400 l/min.	SV 12 MEMBRANE
SV 34	G 3/4"	G 3/4"	G 3/4"	3800 l/min.	14000 l/min.	SV 34 MEMBRANE
SV 10	G 1"	G 1"	G 1"	6280 l/min.	15900 l/min.	SV 10 MEMBRANE

 **Ordering example:** SV 12 **

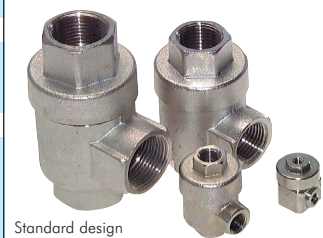

Standard design

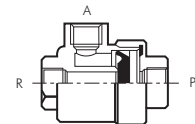

2.2 Dimensions Type SE ...

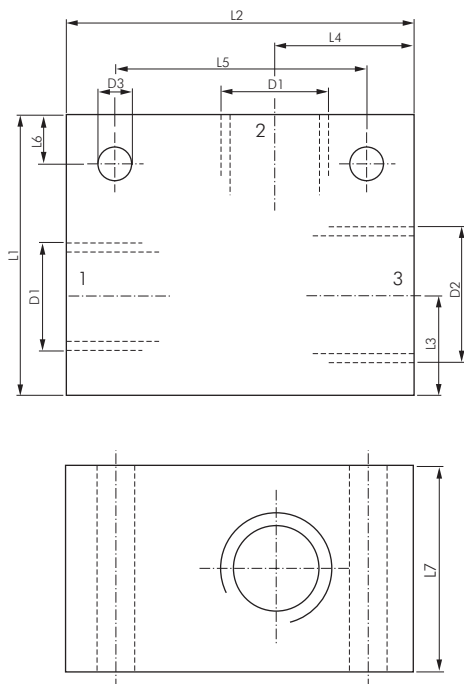

Type	D1	D1	D3	L1	L2	L3	L4	L5	L6	L7
SV 18	G 1/8"	G 1/4"	4,5	32	40	12,5	18	24	6	25
SV 14	G 1/4"	G 3/8"	5,5	40	50	15,0	20	36	7	30
SV 38	G 1/2"	G 3/4"	6,6	56	70	20,0	28	50	10	40

2.3 Dimensions Type SV ...

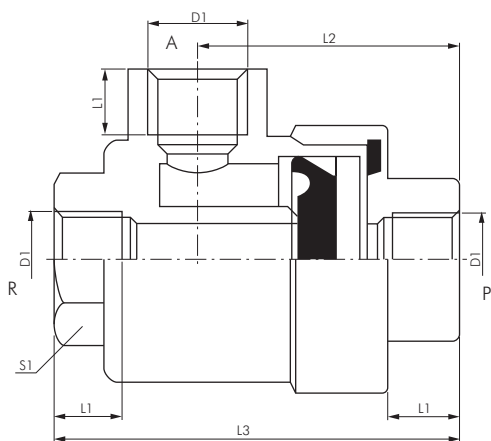

Type	D1	L1	L2	L3	S1
SV 25	M5	5,0	17	25	10
SV 18	G 1/8"	6,5	27	42	15
SV 14	G 1/4"	9,5	35	53	19
SV 38	G 3/8"	11,0	35	54	19
SV 12	G 1/2"	13,0	43	72	26
SV 34	G 3/4"	16,3	53	87	32
SV 10	G 1"	18,0	70	108	46

3. Quick exhaust valves made from stainless steel

3.1 Articulenumbers and technical data

Quick exhaust valves made from stainless steel

Materials: Body: 1.4404, seals: FKM (G 3/8" - G 1/2": PUR)
Temperature range: -10°C up to max. +120°C (G 3/8" - G 1/2": max. +80°C)
Operating pressure: 2 - 10 bar
Media: Oiled and unoled compressed air, as well as non-toxic gasses (50 µm)

Type	Thread	Flow (cylinder -> venting)	Flow (input -> cylinder)
SE 14 ESG	G 1/4"	1900 l/min	1650 l/min
SE 38 ESG	G 3/8"	2880 l/min	2350 l/min
SE 12 ESG	G 1/2"	6400 l/min	4580 l/min

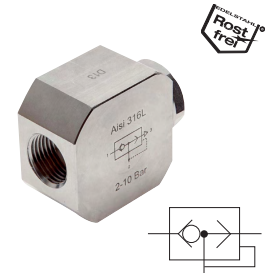

3.2 Dimensions

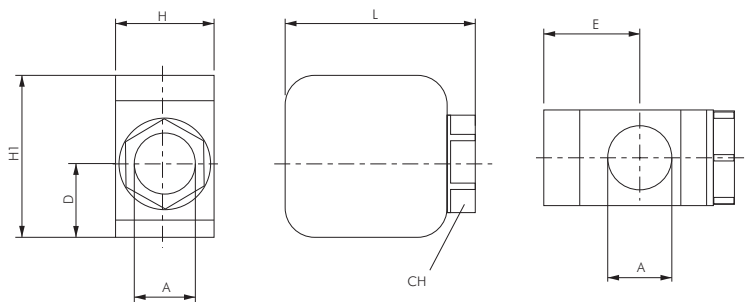

Type	A	H	L	H1	E	D	CH
SE 14 ESG	G 1/4"	20	40,0	33	23,0	13,5	18
SE 38 ESG	G 3/8"	24	50,0	43	24,0	20,0	21
SE 12 ESG	G 3/2"	30	58,5	50	29,5	22,5	27

4. Stainless steel clamp venting valve, compact

4.1 Articulenumbers and technical data

Stainless steel clamp venting valve, compact

incl. Silencer

Materials: Body: 1.4404, seals: FKM, damper material 1.4401
Temperature range: -10°C to max. +150°C
Operating pressure: 2 - 10 bar
Media: Filtered, oiled and unoled compressed air

Type	Thread	Flow (cylinder -> venting)	Flow (input -> cylinder)
SE 14 K ES	G 1/4"	780 l/min	1080 l/min
SE 38 K ES	G 3/8"	1920 l/min	2170 l/min
SE 12 K ES	G 1/2"	2550 l/min	3250 l/min



4.2 Dimensions

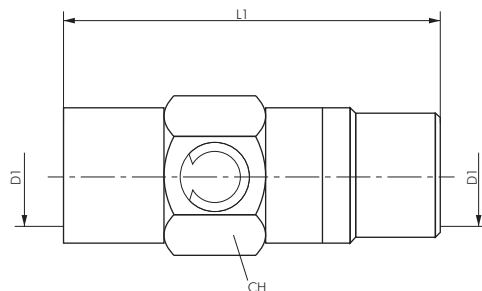

Type	D1	L1	CH
SE 14 ESG	G 1/4"	50	18
SE 38 ESG	G 3/8"	61	27
SE 12 ESG	G 3/2"	69	35